



# SEWING MACHINE ACCESSORIES



# Janome Sewing Machine Compatibility Quick Reference Guide

Use this quick reference guide to determine compatibility of an accessory with your Janome sewing machine.



**A**  
Memory Craft 11000 /  
Memory Craft 11000S Special Edition



**B**  
Memory Craft Embroidery models  
\* Sewing accessories not available for embroidery machines.



**C**  
Memory Craft models  
with AcuFeed system  
(7 mm max. width)



**D**  
Memory Craft computer models  
(7 mm max. width)



**E**  
Top-loading models  
(6.5-7 mm max. width)



**F**  
Top-loading models  
(5 mm max. width)



**G**  
Front-loading models



**H**  
Overlockers  
\*excl models 203,888



**I**  
Cover stitch machines



**J**  
High speed machines



**K**  
Needle punching machines

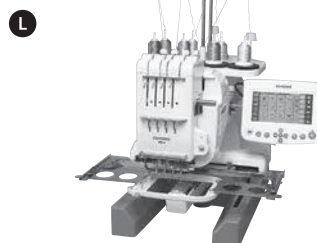

**L**  
Multi-needle embroidery machines



**M**  
Combined overlock and  
cover stitch machines



**N**  
Memory Craft Embroidery models  
with AcuFeed system  
(9 mm max. width)



**O**  
Memory Craft Embroidery models  
(9 mm max. width)



**P**  
Memory Craft models  
with AcuFeed system  
(9 mm max. width)

## Janome Engineering and Craftsmanship for Better Quality Sewing

Exclusive features of Janome presser feet and accessories give you more control and accuracy for a higher quality finish. Calculated for effectiveness and full of originality, you can be assured that the history and tradition of quality Janome engineering is behind not only every sewing machine, but every presser foot and accessory as well.

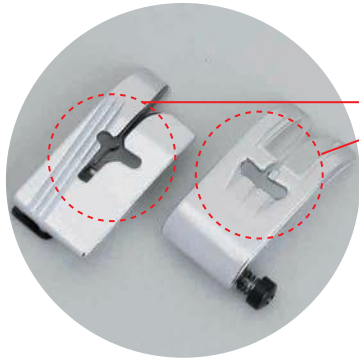

### Grooves guide fabric and thread

Special grooves on the underside of feet promote optimal fabric feed for best results. On the left, the diagonal grooves on the underside of the blind hem foot improve contact of the fabric with the center guide plate for more accurate blind hems. On the right, outlets are provided on the underside of the zigzag foot to help grab the thread as it exits and improve stitch quality.

### Button locks foot tilt

Who hasn't been frustrated by stitching bunching up before a thick seam? Although sewists normally appreciate the free tilt of a sewing foot, sometimes this feature can work against you when the foot comes up against a thick seam. To help you have perfect stitching over even the thickest seams, Janome provides a button on the zigzag foot that locks it horizontally parallel to the thread plate for smooth sewing over seams or other areas of significantly varying thicknesses. This feature can also be used at the beginning of sewing thick fabrics for a perfect start.

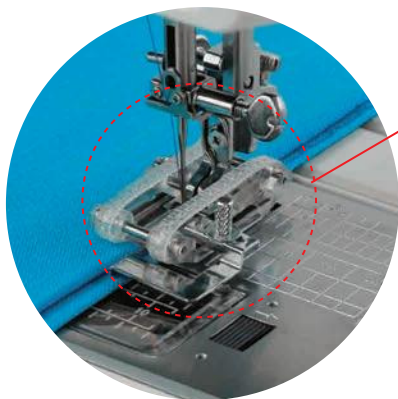
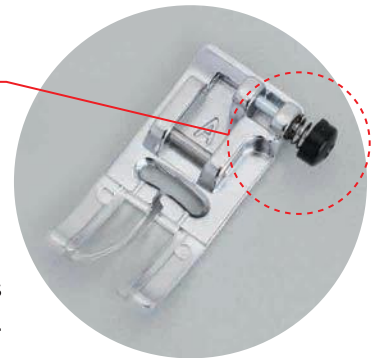

### Caterpillars for better control

Most presser feet are flat. But what do you do when there is a significant difference in the height of the fabric on the left of the needle from that on the right, such as when finishing hems and edges of thick material? This is where the unique design of the Janome rotary even foot comes into play. The foot allows left-right tilt and its caterpillars independently grip the fabric for exceptional control, even over thick seams.

### Multiple functions in one presser foot set

From idea to reality. When our customers say, "Wouldn't it be handy if...", we listen to their ideas. The feet that come with the convertible FMQ set are interchangeable and the guide on the 1/4 inch clear-view quilting foot can be removed. This means the feet can be matched precisely to the purpose with 1 set providing a range of functions. That's why these items fulfill user needs and are proving to be popular.

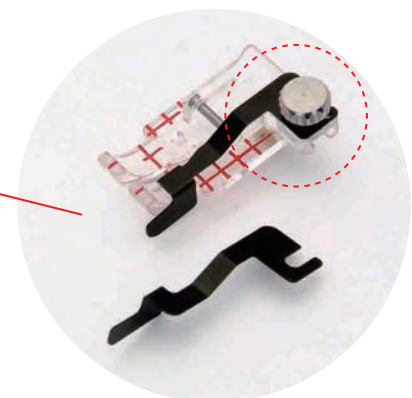



## ACUFEED: Layered Fabric Feeding System

Janome truly integrates a built-in walking foot with a unique seven point feed dog system. Since the top layer is fed in perfect timing with the bottom layer, all fabrics move smoothly, even the slippery ones like velvet or thick layers of quilting fabric and batting, and heavy home dec yardage. Perfect feeding also means perfect alignment of patterns such as checks and plaids.

## ACUFEED FLEX™

In addition to the original twin type, single type feet can now be used, expanding sewing possibilities. AcuFeed Flex™ keeps your thickest, trickiest layers moving in perfect sync with the feed dogs. You're going to love the new AcuFeed Flex™ feet for stitching your fluffiest quilts, installing zippers, or matching seams!



The AcuFeed Flex™ fabric feeding system is fully detachable and easy to remove when you're not using it. Select the presser foot that best matches your sewing needs and attach. Simply snap off when not in use and store out-of-the-way in one of the ample accessory trays. Multiple twin type and single type feet are available to address different tasks.



**Dual feed twin type:**

The twin type dual feed attachments give you superior stability by taking full advantage of a wider stance. Engage the exclusive AcuFeed™ /AcuFeed Flex™ fabric feeding system and feel your project moving together under the needle with perfect precision.

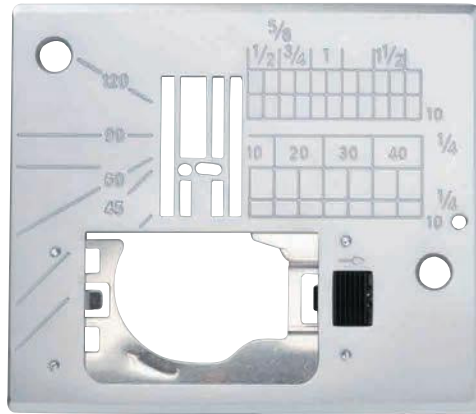

**ACUFEED 1/4 INCH SEAM FOOT AND NEEDLE PLATE**

Guides edge of fabric to help you sew perfect 1/4 inch seams, especially useful for patchworking. The small needle hole on the needle plate prevents fabric from being pushed under the needle plate.

846-407-007	C
-------------	---

\* Needle plate only compatible with MC6600P

**ACUFEED 1/4 INCH SEAM FOOT**

202-031-002	C
-------------	---

**ACUFEED QUILT PIECING FOOT**

202-125-004	N P
-------------	-----



**ACUFEED OPEN TOE FOOT**

Front of foot has been removed for clearer visibility when sewing. Great for applique, monogramming, cutwork and quilting.

846-410-003	C
202-149-004	N P



**ACUFEED DITCH QUILTING FOOT**

Center-position guide follows a seam line precisely, allowing perfect in-the-ditch quilting. Used in conjunction with various needle positions, it is also perfect for topstitching or understitching a facing.

846-413-006	C
202-103-006	N P



**ACUFEED STRAIGHT STITCH FOOT**

The circle hole in the foot holds the thread in place and allows for a quality straight stitch. Using together with straight stitch needle plate is recommended.

202-102-005	N P
-------------	-----



**Dual feed single type:**

The single type dual feed attachments let you get in close to sew a narrower area as well as the edges of cloth. Standard and zipper single type feet available for AcuFeed Flex™ fabric feeding system only.



**ACUFEED FOOT WITH FOOT HOLDER**

This foot has the power to feed fabrics. It is especially effective for top-stitching on the edge of the fabric and stitching on narrower strips.

202-127-006	N P
-------------	-----



**ACUFEED ZIPPER FOOT**

Zippers can be attached to plastic coated fabric, leather and any tricky to handle materials without any difficulty.

202-128-007	N P
-------------	-----



# QUILTWORK

Quiltwork has a long history. Traditional quilting includes the use of patterns and designs that can date back hundreds of years. More recently, quilting has received increased recognition as an art form, with museum exhibitions becoming less uncommon as it grows in popularity. Quilts add warmth to our lives, and not just as bed coverings. Janome accessories make the mechanics of quiltwork easier so you can focus on letting your creativity flow.

## EVEN FEED FOOT



The even feed foot walks over fabric to assist with smooth feeding. With this foot fabric can be sewn without puckering, as the fabric is gripped and fed by both the upper and lower feed dogs. Use the quilting guide for perfectly spaced parallel lines of stitching or to form a wider seam allowance.





It is said that each piece of quiltwork is as unique as the sewist creating it.

Let Janome help bring out your creativity whether through a large quilt enjoyed as a wall hanging or comfy throw, or a smaller creation such as a toss cushion or even incorporated into daily objects such as a unique tote, case or holder.



#### 1/4 INCH SEAM FOOT



Sew a 1/4 inch seam allowance quickly and accurately. Great for patchwork which traditionally uses 1/4 inch seams.



## Mix different colors and textures

Not only can various colors of fabrics be combined into a quilt, but you can have fun mixing and matching textures by incorporating various sewing techniques. For example, contrast embroidery with crazy free motion stippling or simple straight lines of quilting. The possibilities are endless when you have the right tools.



### FREE MOTION QUILTING FOOT



The adjustable height foot holder design ensures quieter, more stable movement for free motion quilting and stippling. The high shank gives you better visibility, so nothing gets in your way, making for the smoothest free-motion.



## Kids love quiltwork.

What better way for them to start the day than being greeted at their bedside by a patchwork teddy bear you have made. Or packing library books into their own special quilted tote bag. The wonderful feeling of handmade quiltwork is sure to be loved by all the children in your life.



## CUSTOM CRAFTED ZIGZAG FOOT

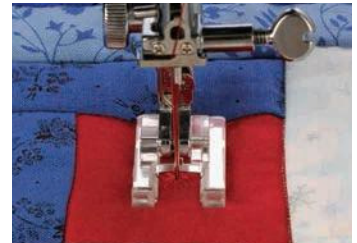

The open toe allows for a better view of the stitches as you sew and the wide groove on the underside allows satin and other decorative stitching to pass through unobstructed. Use this foot for quilting, monogramming, applique and cutwork.

## DITCH QUILTING FOOT



Use this foot for perfect placement when stitching in the ditch. The guide follows the seam line keeping the stitch line perfectly straight, and can also be used as a center guide for applying applique or aligning with a pre-marked guide line.



# HOME DEC

Are you satisfied with how your home is decorated? Whether it's a room you spend a lot of time in or a room you like to show off to guests, the right color coordination can make a room comfortable and inviting. Finding the perfect hue can be downright daunting, so increase the possibilities by creating your own or embellishing existing home dec items. And let Janome's accessories help you add a professional flair with ease.



## Keeping it simple for a sleek modern look

Limit your color palate to a few colors and pull the room together with a variety of fabric textures. Why limit yourself to flat fabrics when you can add textures through the use of techniques such as a checkerboard of pintucks. Texture can also be added with similar hued cord or embroidery floss.



## A fresh look for your table

Start with a simple color palette of a few fresh colors. Then add your own embellishments in coordinating colors for flair. Thread based embellishments are perfect for placemats where you want to maintain a flat surface. Add distress to pintucks on a coarser fabric for a softer well-loved look and feel.



### PINTUCKING FOOT + CORD GUIDE



Use a pintuck foot together with the cord guide to create corded pintucks. The grooves on the underside can be matched up with a previously sewn pintuck for perfectly spaced rows.

### 3-WAY CORDING FOOT



The slots in this foot will hold one to three lengths of cord in place while stitching a decorative stitch over the cords.

### PIPING FOOT



This foot is for making and applying piping. The corded part of the tape fits under the left groove on the bottom of the foot. Can also be used with prepared piping or specialty piping.





## Brighten up a plain room

A simple room can be instantly energized by adding colorful accents. For maximum impact with minimal effort, attach shiny embellishments such as ribbons, strands of beads or sequins in contrasting colors. It's a breeze when using Janome's beading foot or ribbon/sequin foot.

### GATHERING FOOT



Used for creating soft gathers quickly, the size of the gathers is determined by the weight of the fabric, stitch length and needle thread tension. Sew one layer of fabric only.

### BEADING FOOT



Makes sewing on continuous beads a dream. Select a zigzag stitch and alter the stitch length and width to ensure that the stitch goes over and between the beads.

### RIBBON/SEQUIN FOOT



A specialty foot for easy application of ribbons and sequins. Insert the ribbon into the hole of the guide and pull a little of the ribbon to the back of the foot. Select a stitch and begin sewing.



# HEIRLOOM SEWING

Heirloom sewing, which is also called French sewing, originally referred to the adding of delicate hand embellishments to create clothing and other objects that can be passed down from one generation to the next. Some of the different techniques used in heirloom sewing include pintucks, fine embroidering, lace insertion and edging, and many other embellishments.

In recent years heirloom sewing has experienced a dramatic resurgence in popularity, in both clothing and home dec. While the attention to detail required can be daunting to the beginner sewist, it needn't be when you have the right tools. As the most important element in heirloom sewing is precision, your Janome sewing machine is a perfect fit, and using the appropriate foot will make creating beautiful heirloom effects a pleasure.





### SATIN STITCH FOOT



Designed for stitching dense satin and decorative stitches, the bottom of the foot is beveled to allow smooth delivery of thread under the foot while securely holding the fabric to the feed dogs. Increased presser foot pressure may be needed when adding decorative stitching to a single layer of a lightweight fabric. Get the best results on fine fabrics by applying lightweight tear-away stabilizer.

## Let the details take center stage.

Start with the highest quality fabrics and threads to ensure your creations maintain their beauty for years to come. Carefully plan your embellishments and test before sewing your actual project. Then let the precision of your Janome sewing machine and accessories do the work.

### ROLLED HEM FOOT



Makes a delicate 2 mm rolled hem on lightweight fabrics, automatically rolling the fabric for you. Especially useful on edges such as ruffles where you do not want to add any bulk to the edge.

### PINTUCKING FOOT



Delicate twin-needle pintucks are a breeze with the grooves on the underside of the foot. Pintucks are not only decorative, strategically placed they can also be used to add a touch of modesty to light weight fabrics.

## Modern Heirloom

While heirloom techniques may be steeped in tradition, they are in no way tradition bound. Although traditional heirloom is monotone or accented with pastel colors, modern heirloom combines the delicate techniques with brighter colors, patterns, and even pairs with techniques such as deconstructed seams for a touch of old but new.



Use delicate heirloom techniques to add just the right amount of color and accent to a plain white collar.

## BUTTONHOLE FOOT

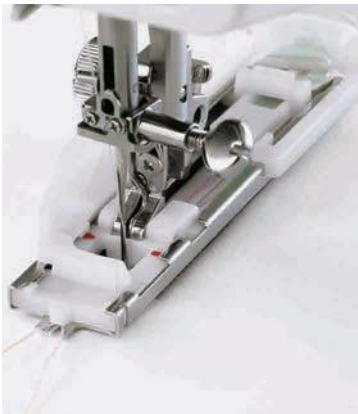

Thin fabrics call for finer threads and needles, but what if you are making a buttonhole in a delicate blouse? Add cording to give strength without bulk. Hook fine filler cord around the spur on the back of the buttonholer and up through the forks before sewing the buttonhole.

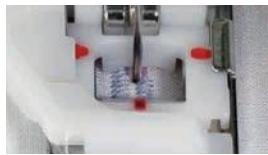

## PINTUCKING FOOT + CORD GUIDE



Use dark colored embroidery floss to add colored shadow effects to sheer fabrics.





## From generation to generation

A special garment to welcome a precious new baby. Delicate embellishments on the finest of linens show the loving care with which it was made. More than just something to wear, a cherished treasure to become part of a family legacy for generations to come.

### WING NEEDLE



Metal extensions on each side push aside threads of the fabric to create the prominent holes in hemstitching. Best used with woven natural fiber fabrics such as linen or cotton, softer fabrics with less body can be stiffened up with starch for better results.

### CUSTOM CRAFTED ZIGZAG FOOT



The open toe allows for a better view of the stitches as you sew, especially when used for applique or when precise alignment of stitches is required. Apply a thin tear-away or dissolving stabilizer before stitching lighter weight fabrics.



Increase your repertoire of heirloom techniques. Moving beyond pintucks, add rows of ladder-stitch attached ribbon interspersed with hemstitching and embroidery-like decorative stitching.